

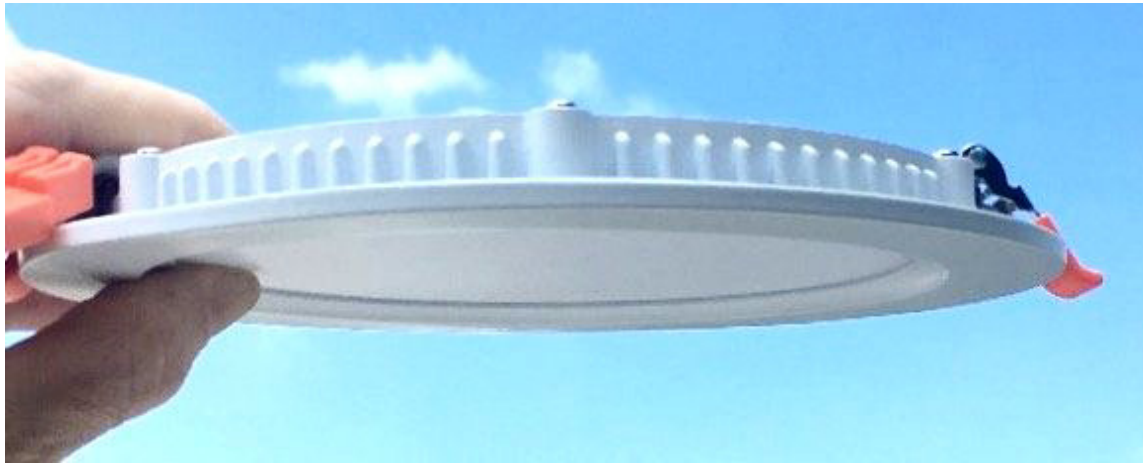

ATX LED Consultants Inc  
 1108 Lavaca St – STE 110-489  
 Austin Tx, 78701  
 512 377 6052  
<http://atx-led.com>

LED Fixtures – Low Voltage  
 Direct 48v/51v Operation  
 Built-In current limiter (CL)  
 Fixed Color Temperature

**P023R6 series, CL**  
**(P023R11 series, CL)**  
**ETL 5005242 / UL 1598**  
**Bright Cool LEDs**



[Product Description - low profile long life LED fixture](#)

The P023R series of LED fixtures are ETL listed and IC rated for direct contact with insulation – recognizing it’s cool operating temperatures and distributed heat ( no hot spots).

[Technical specifications](#)

Lumen/ watt, CRI	100 lm/watt CRI 90
P023R6 wattage, current	6 watts 0 to120 mA
P023R11 wattage, current	12 watts 0 to240 mA
Inrush Current	120 mA max / 240mA max
Dimming Range	Individual: 0 to 100% Circuit: 2.5% to 100% recommended
Color Temperature	4 options available
Dimming Voltage (48v)	35 to 42 volts – Dimmer recommended
Dimming Voltage (51v)	43 to 49.5 volts – On/Off switch or CL51 dimmer
Recommended wiring	Parallel wiring method
Internal Constant Voltage (CL)	Operates directly from DC – no external current limiting required
Operating Temperature	Ceiling mount, -20 to 50 Deg C non condensing
IP Rating	Suitable for Damp environments
IC Rated	Yes, (see AL-CBOX4 Fire Rated Rough In box)
LED Type	2835
Connector	OJ-606 ( male/female set included)

## 4 inch Direct to Sheetrock / wood Option

Side springs shown in main photo

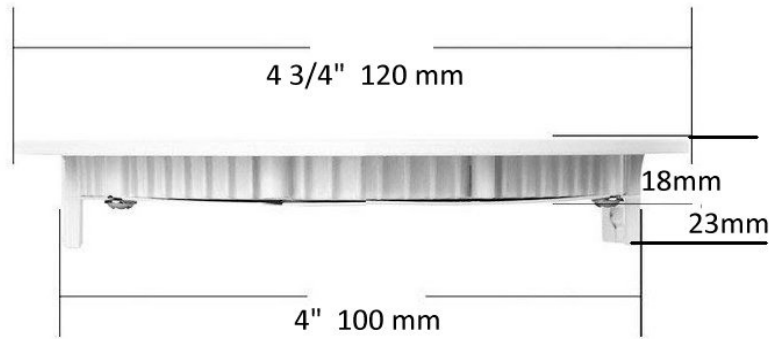

## 4 inch AL-CBOX4 ceiling mount Option

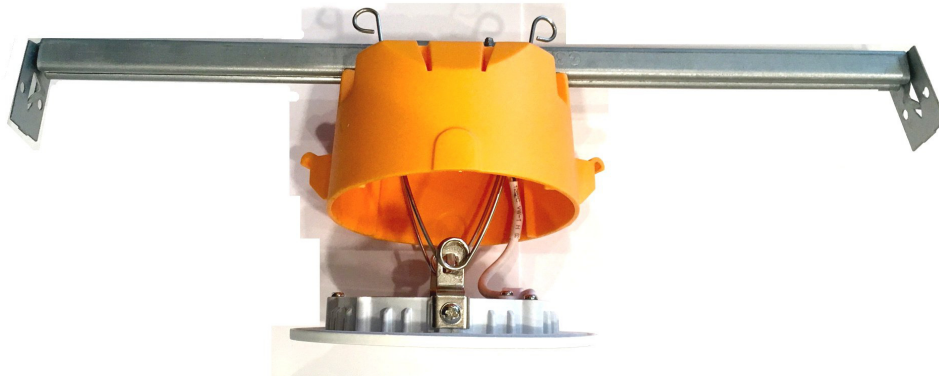

AL-CBOX4 mounting hanger bar

16 to 24 inch joist spacing  
Supports up to 20 lbs  
Flat or vertical truss attachment  
See [AL-CBOX4.pdf](#)

## 4 inch Metal Plate mount Option

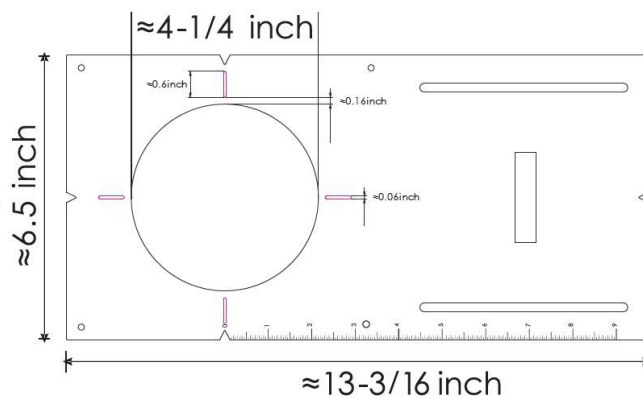

## 6 inch mounting options

**P023R11 ( 12 Watts )**

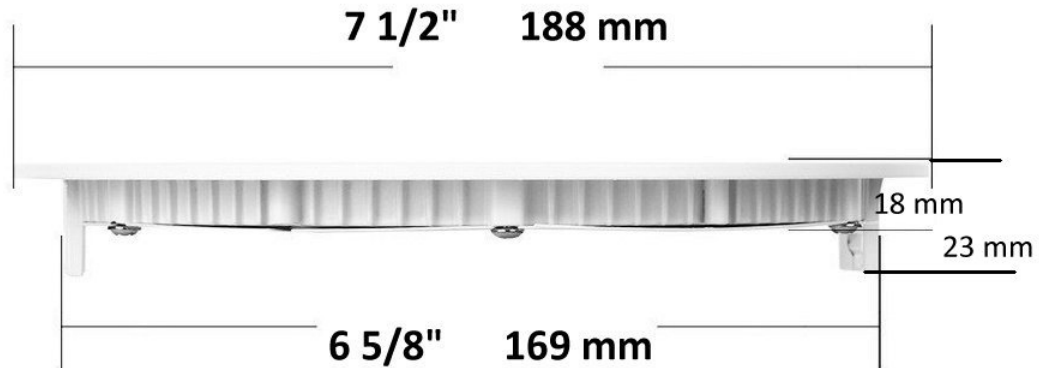

## AL-CBOX6 ceiling mount Options

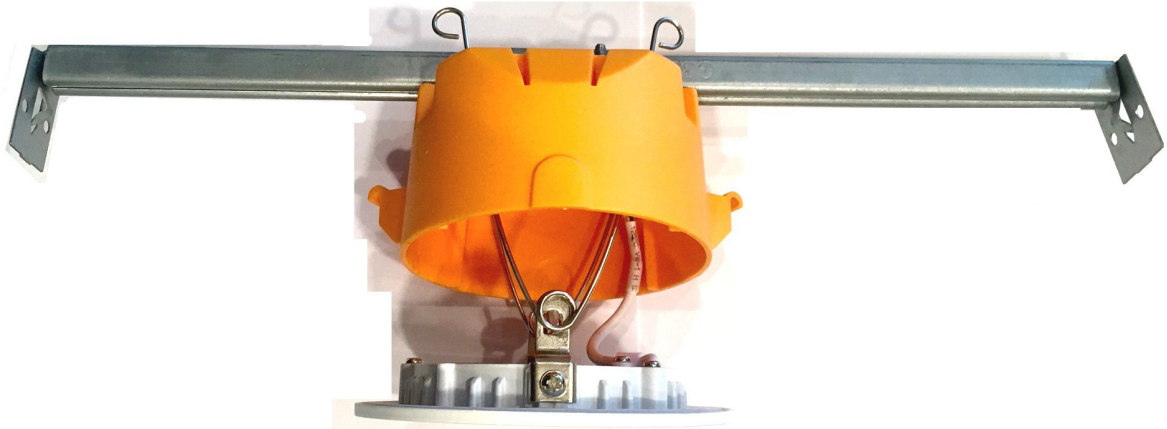

**AL-CBOX6** mounting hanger bar

16 to 24 inch joist spacing  
Supports up to 20 lbs  
Flat or vertical truss attachment  
See **AL-CBOX6.pdf**

## Fixed Color Temperature options

Available in different color temperatures, these fixtures are operated as a fixed color. Any 48 volt supply can be used. Up to 16x 6 watt or 8x 12 watt fixtures can be wired in series to share simple On/Off switch. That driver can be located up to 150 ft from the LEDs – since constant current eliminates the concerns about voltage drop.

Model	2700	3000	3500	4000	5000
4 inch	*	X	X	*	*
6 inch	*	*	X	X	*

X= Stock, \* = special order with MoQ

## Ordering part numbers

Model	Dimming Range	Dimmer	Max Voltage	Current	CCT	CRI	Lumens
P023R6-48v6w-3000K	35-42	AL-WS-DR	48v	0-120mA	3000K	90	540
P023R6-48v6w-3500K	35-42	AL-WS-DR	48v	0-120mA	3500K	90	540
P023R6-48v6w-4000K*	35-42	AL-WS-DR	48v	0-120mA	4000K	90	540
P023R6-51v6w-3000K	42-47	SRPL-2309	51v	0-115 mA	3000K	90+	640
P023R6-51v6w-3500K	42-47	SRPL-2309	51v	0-115 mA	3500K	90+	640
P023R6-51v6w-4000K*	42-47	SRPL-2309	51v	0-115 mA	4000K	90+	640
P023R11-48v12w-3000K*	35-42	AL-WS-DR	48v	0-240mA	3000K	90	1080
P023R11-48v12w-3500K	35-42	AL-WS-DR	48v	0-240mA	3500K	90	1080
P023R11-48v12w-4000K	35-42	AL-WS-DR	48v	0-240mA	4000K	90	1080

\* special order with MoQ

# Wiring example

## spare pair allows upgrading

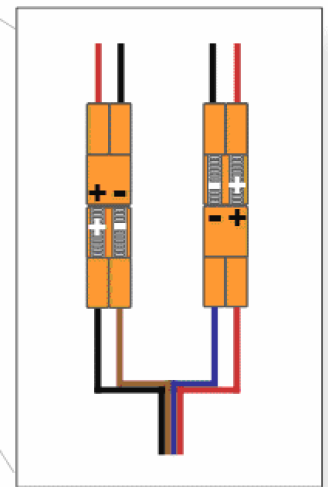
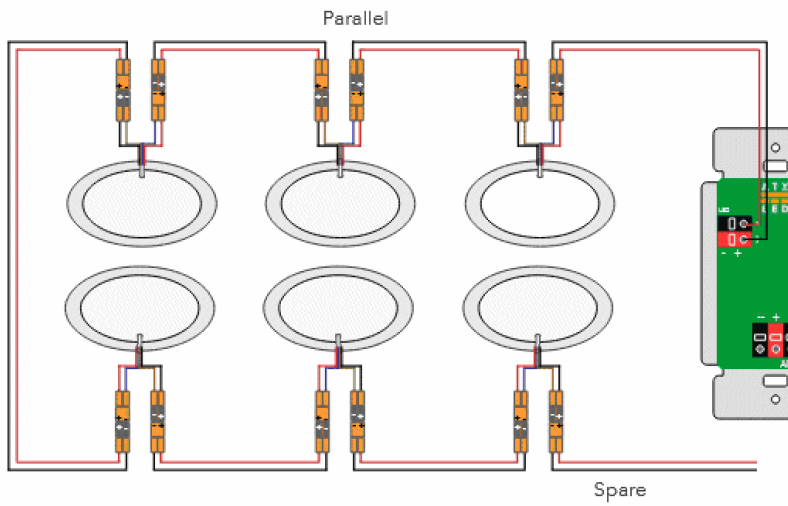
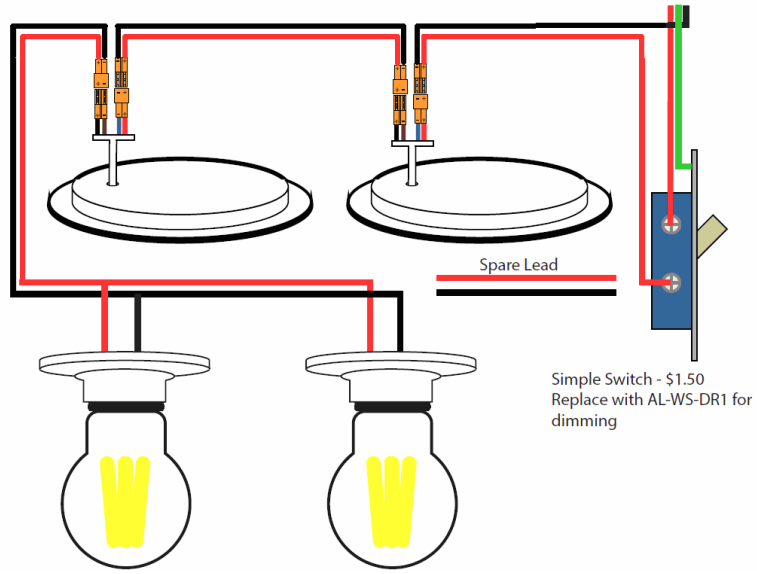

Connection Detail

## Recommended DC Dimmers – 48v models

DC drivers	Driver input Voltage	Minimum Dimming	# of 6w LEDs	WiFi	DALI
AL-WS-DR2	51v	.1%	12		X
AL-WS-DR1	51v	5%	4		
AL-WS-DR2C	51v	.1%	12		
AL-WS-DR2W	51v	.1%	8	X	

Please adjust the max current to be less than 125 mA per attached LED, this will insure maximum efficiency. This graph assumes 51v open load voltage and a variable current drive level.

VI curve of 48v LEDs

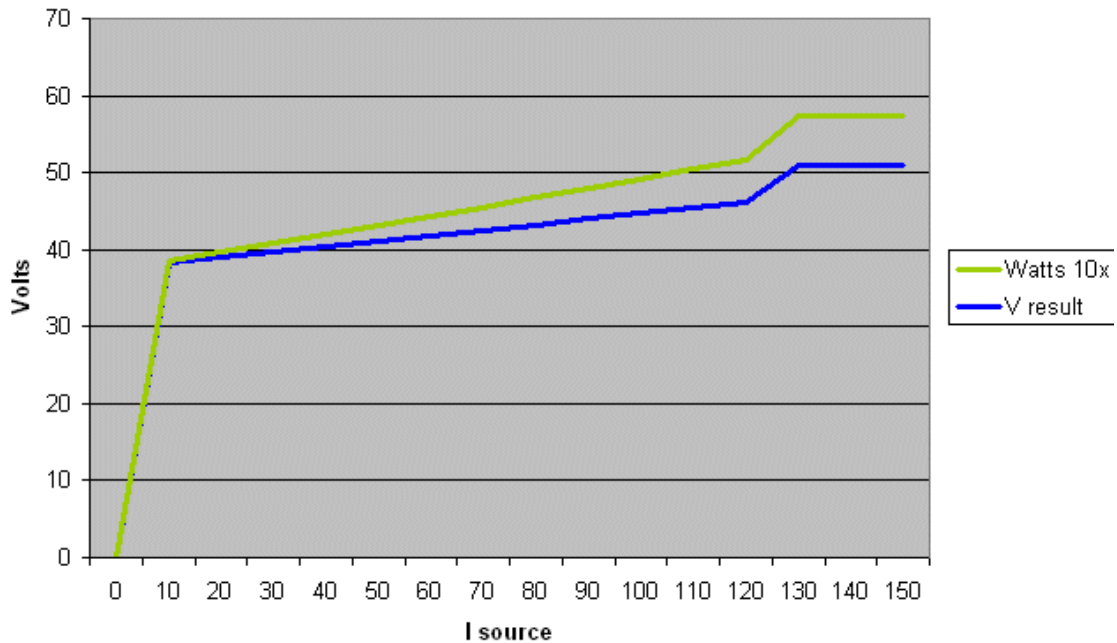

## Dimmers – 51v models

DC drivers	Driver input Voltage	Minimum Dimming	# of 6w LEDs	WiFi	DALI
On/Off Switch	51v		16		
SRP-2305-75	120vac	1%	12		X
ELG-150-48DA	120vac	1%	24		X

Please adjust the max current to be less than 125 mA per attached LED, this will insure maximum efficiency. This graph assumes 51v open load voltage and a variable current drive level – when the current exceeds 125mA per load – the voltage jumps to the max value and the efficiency drops.

### DF42 Connector wiring

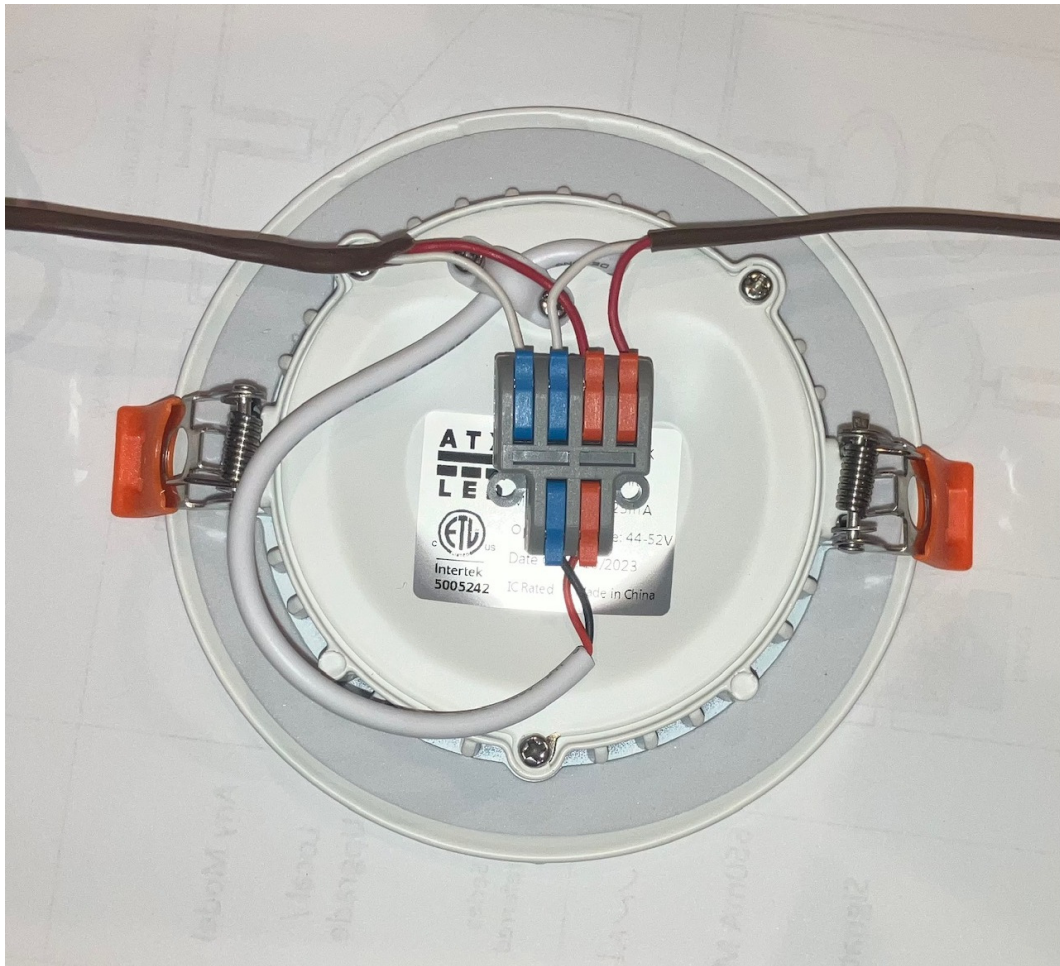

# Meet the DR2

The DR2 is the heart of the entire system. From the front it looks like a typical style wall switch with a slide dimmer. This is where the driver for the LEDs is located. The DR2 uses current control technology to provide perfect dimming to each of its corresponding LEDs. There are several different types of DR2 available, depending on application.

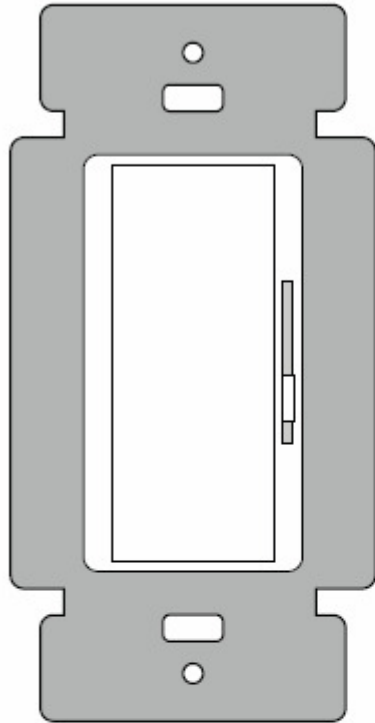

Front

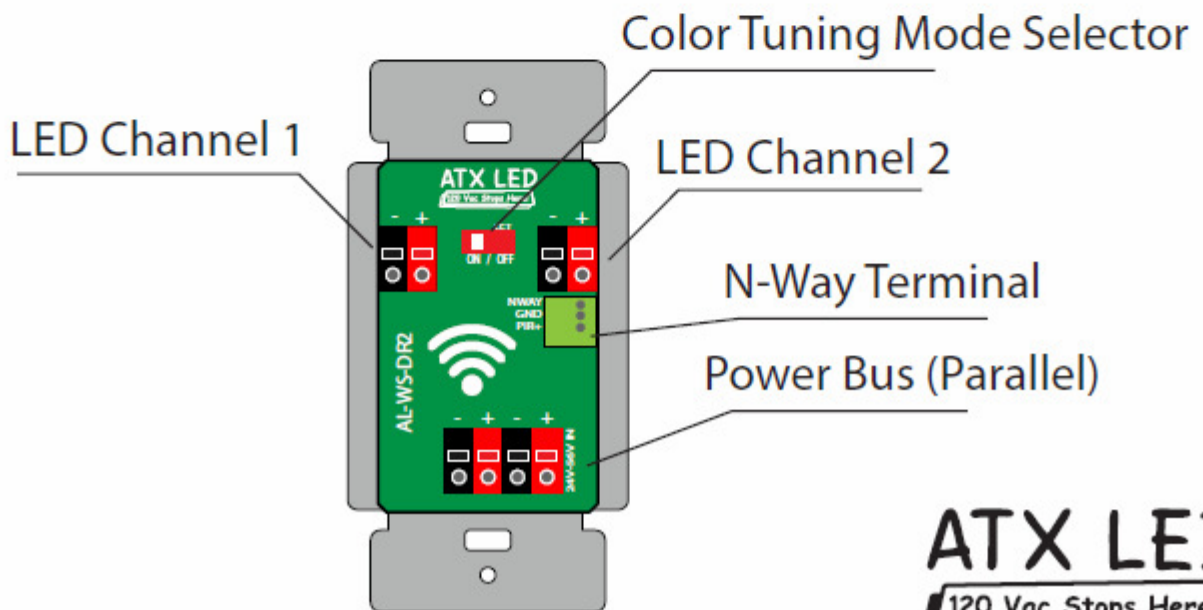
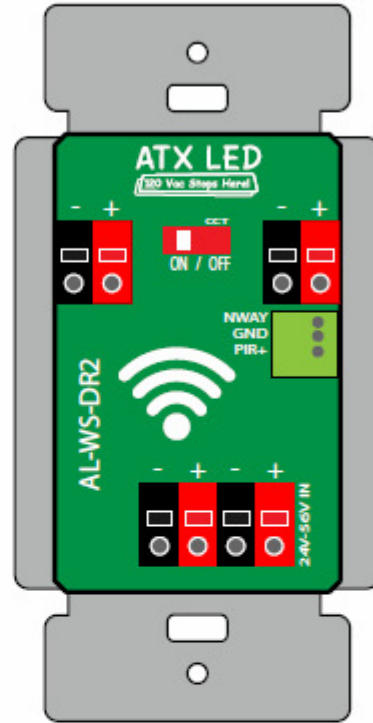

**ATX LED**  
120 Vac Stops Here!