

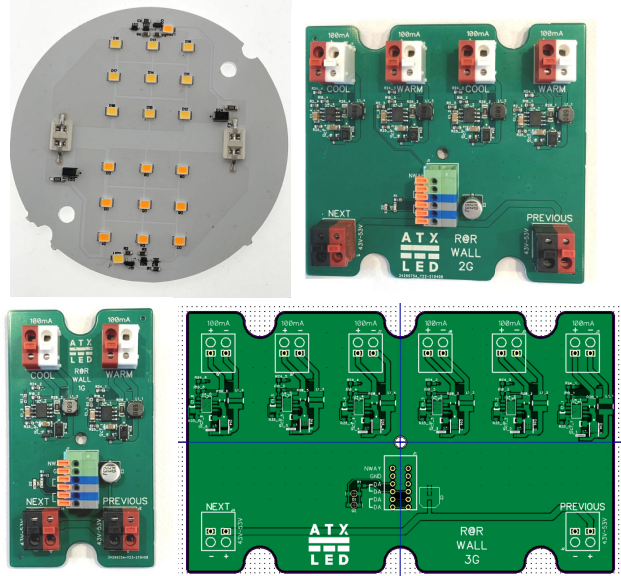

ATX LED Consultants Inc
815-A Brazos #326
Austin TX, 78701
512 377 6052
<http://atx-led.com>

Ready @ Rough™ AL-R@R-Work-CCT

Wiring Validation,
Wire protection and Safe
Temporary Lighting for New
Home Construction



Protection

R@R protects the wires from other trades – the wires are behind plates that are difficult to cut, and can be coated in mud without damage. The surfaces can be washed after trim for the next project

Light

R@R provides work lighting from the moment wiring is installed – this can provide light weeks or months ahead of Final, while other trades complete their work. Besides validating all wiring, useful light is provided, and light is lost the moment a wire is cut.

Safety

R@R uses isolated low voltage and low current to provide the light. Shorts by other trades are energy limited, reducing contact risk and the surprise of high energy sparks.

Product Description - Ready @ Rough®

This kit solves these problems for wiring in new construction

- Protects wires from Rotozip tools
- Protects wires and openings from sheetrock mud and paint
- Provides light during construction before sheetrock – low voltage, low current, isolated and safe
- Verifies all wiring prior to sheetrock, eliminates fingerprints at trim
- Saves time at trim, 3 models are available to match the final bulb type, CCT, Fixed, E26
- Washable diffuser lens to allow reuse
- No deformation of the wires
- Visual immediate reporting of trade wire damage



High or Low voltage Ceiling boxes can be used

Blue is the Carlon B620K

Orange is the ATX LED CBOX4

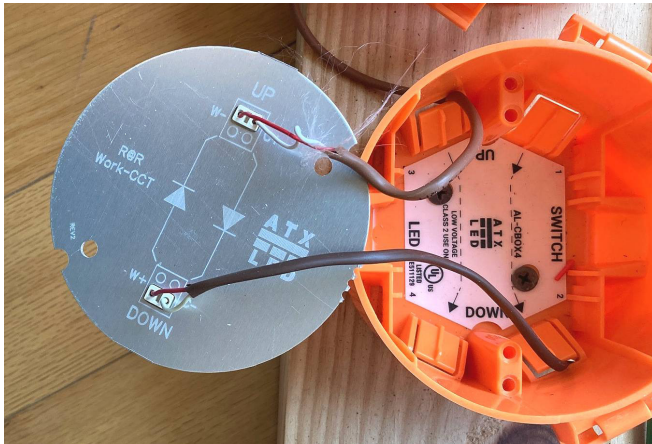

Ceiling R@R® “work” device

LED light and protector

- Connect the wires in the box
- Simple to wire, clearly marked Up and Down
- Screw onto the 8-32 recessed screws using screetrock screws
- Dust cover and Diffuser – easy clean up for the next job
- Diffuser keeps mud away from wires and openings, wire marking or labeling and the LEDs



R@R® “wall” device

Light switch placeholder and driver

- Connect the wires in the box
- Simple Power wiring – Red to Red, Black to Black, clearly marked Previous and Next. Blue LED shows power
- Simple LED wiring - Red to Red, White to White clearly marked Up and Down – White LED shows current available
- Simple Control bus verification – indicator LED for correct wiring.
- Press the device back up into the box – the wires hold it in place
- At the Home Run – plug into the power distribution panel
- Validate the N-Way wiring
- Scrape off mud / paint and use on the next job

Lighting up the project using safe low voltage as soon as the Rough wiring is in

First Step – the wire pulled into boxes

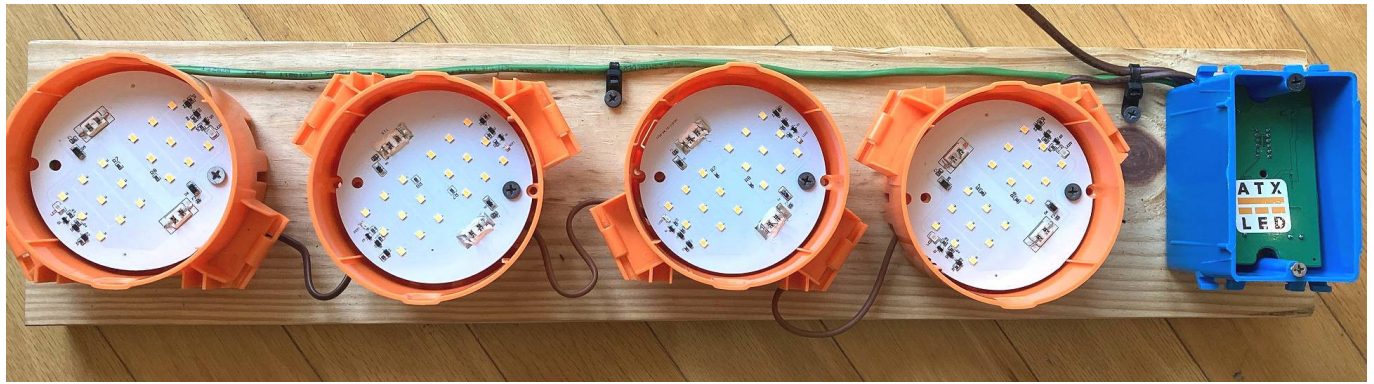

Next Step – the wires are connected and ready for Light at Rough

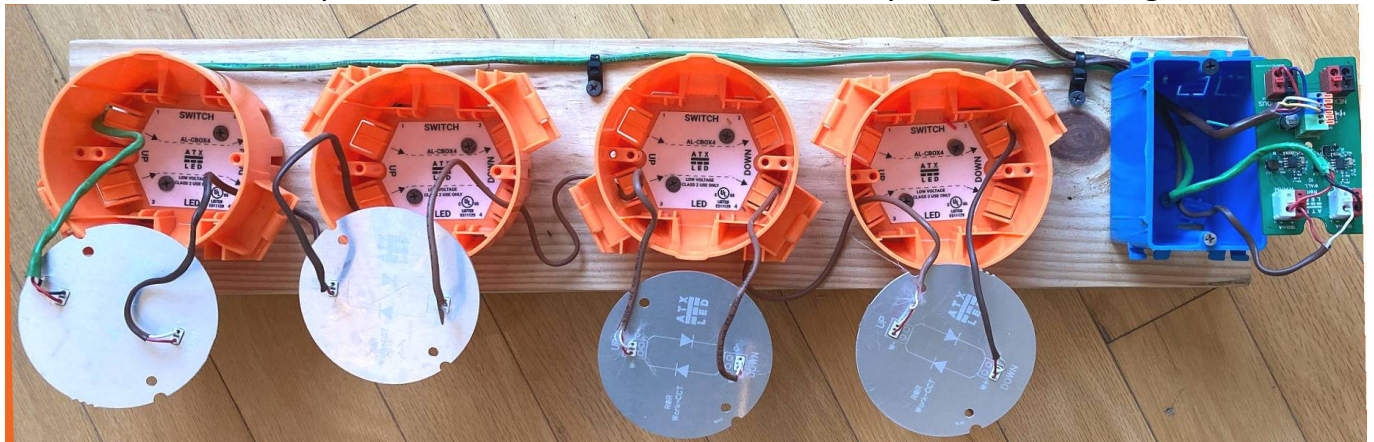

Ready for sheetrock – work lighting too - long before Final Electrical

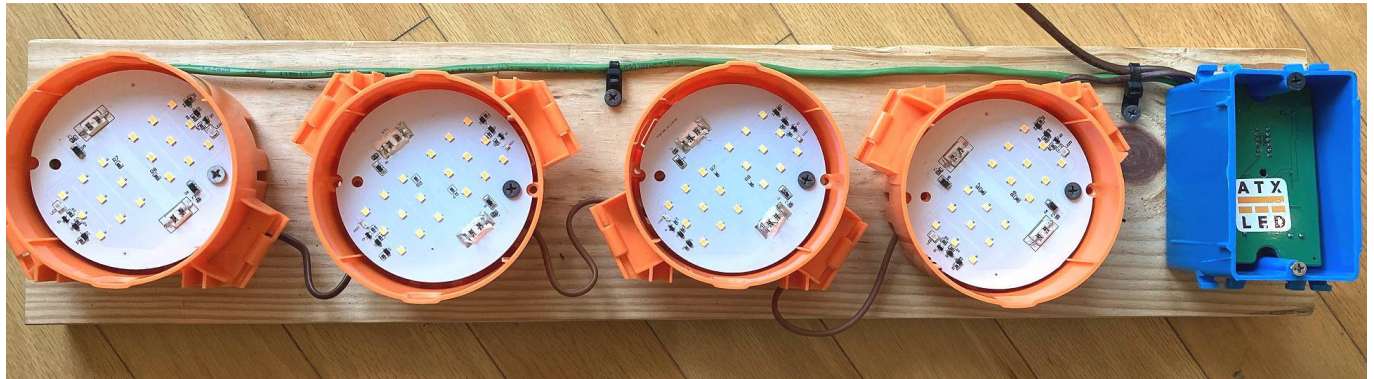

Diffuser and paint protection

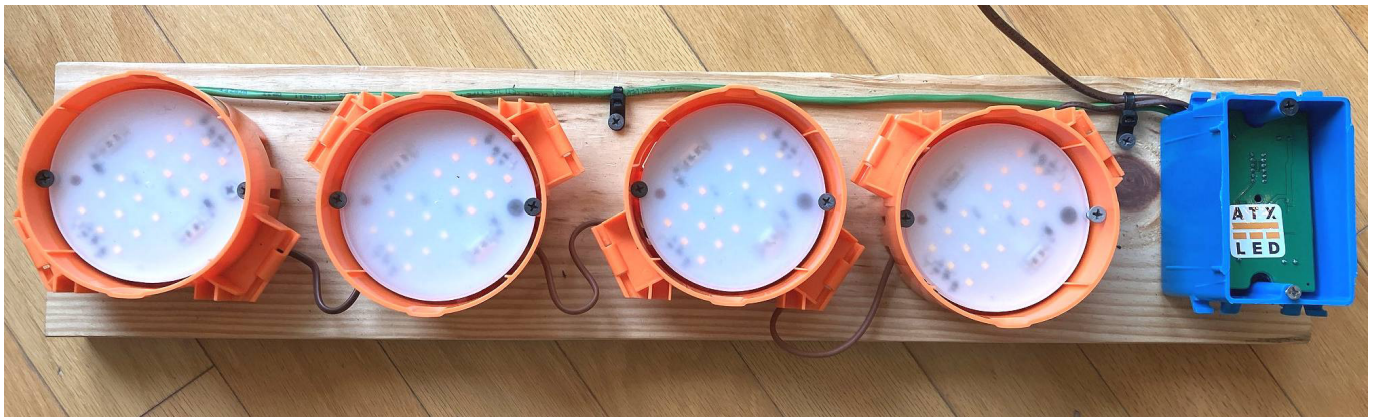

After wallboard - Quickly Trimmed and ready for Final and CO



Product Description - AL-R@R Solution

AL-R@R Work – Temporary LED

- provides work lighting in all rooms of the project
- verifies all wiring
- moves cut, stripping and wire testing to Rough stage
- protects from Rotozip™ and mud
- faster trim
- Fixed and Tunable white versions
- Re-usable – wash the mud off and reuse
- Use a sheetrock screw to extract after painting
- Indicates reversed wiring
- Indicates under voltage conditions
- Off if a wire is cut
-

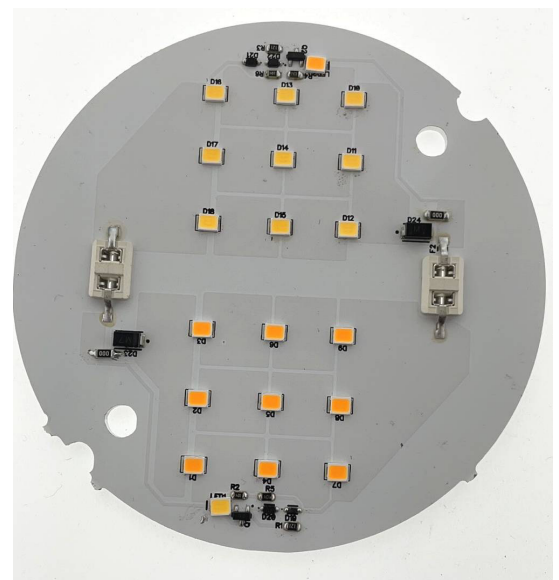
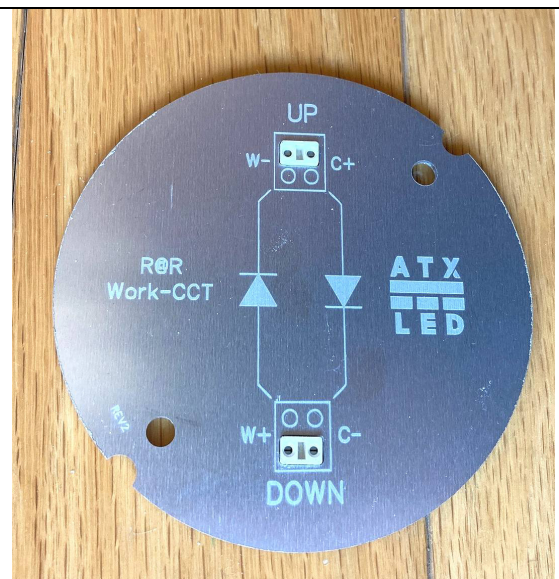

AL-R@R Wall – Temporary Wall Switch

- provides current to the work lighting
- moves cut, stripping and wire testing to Rough stage
- protects from Rotozip™ and mud
- faster trim
- Re-usable – wash the mud off and reuse
- Use a sheetrock screw to extract after painting

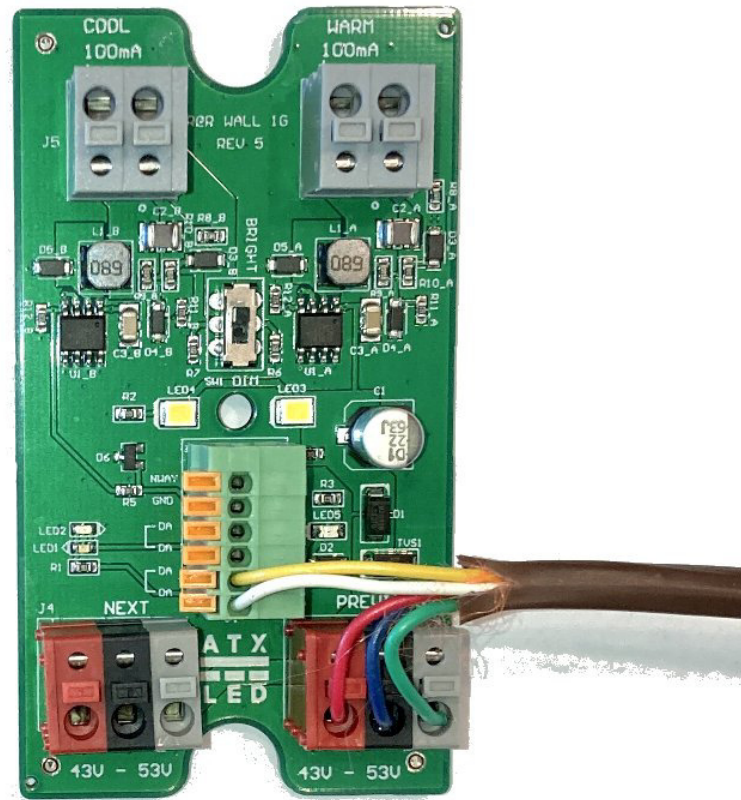

Wiring the AL-R@R solution

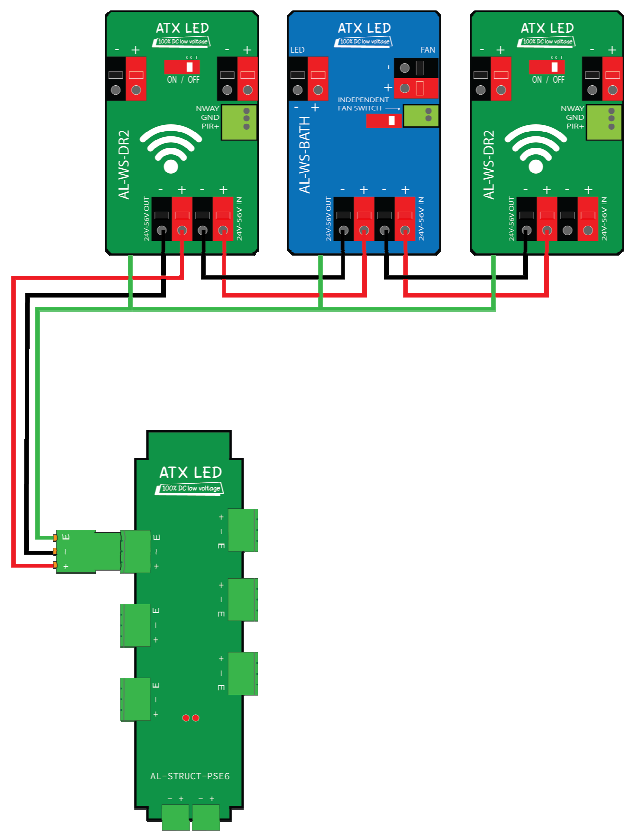
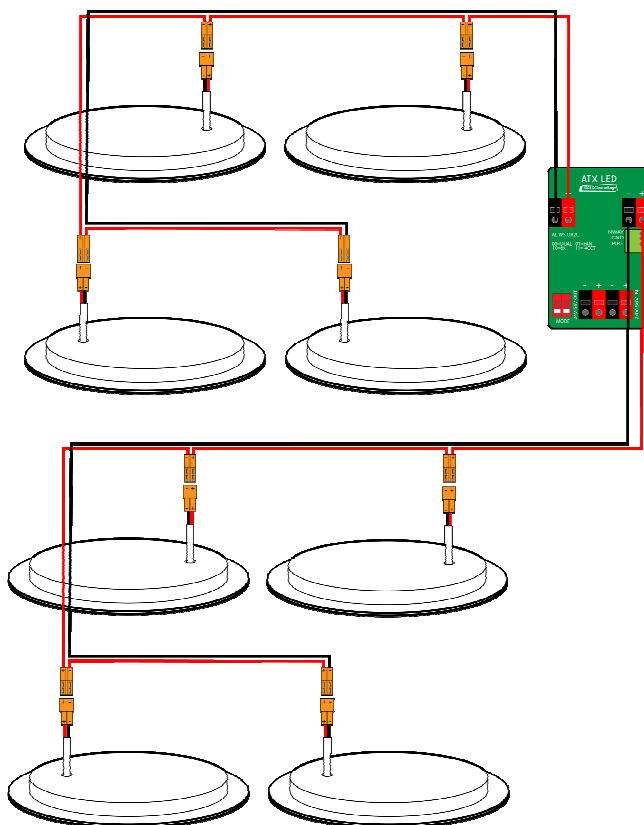

AL-PSE48-sml

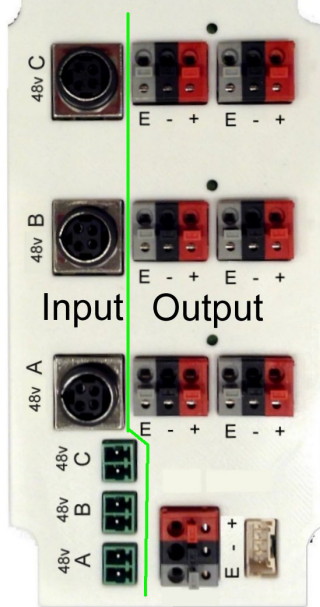

Power distribution

Production power panel installed and operational at rough

- Use the device to provide power and control:
AL-PSE48-sml
AL-PSE-4D or
AL-DALI-8 or
AL-DF10
- An AL-PS-51v96w is required for power
- Ready for work lighting, replace with final at trim
- Red wire to +
Blue wire to -
Green wire to E
Yellow and White are not connected on the PSE48
- Yellow and White are connected to D+ and D- on the PSE-4D,
AL-DALI-8 and AL-DF10

Error Recognition

Ready @ Rough allows all the wiring in a house to be validated and activated prior to wallboard. This is a major time saver – and clearly shows if the wallboard or other trades have damaged the wiring.

Too many series LEDs

If more than 5 LEDs are wired in series – then instead of 9 LEDs per side, only one White LED will be on, at a low dimming level. Make the loop shorter and have only 45 volts (5x 9 volts) of LEDs in series, or convert to the parallel wiring method using the 48v6w product line.

Backwards LEDs

If LEDs were wired backwards, the device will show a Red light. Other LEDs in the chain will operate with white light – but at a low dim level. Once the reversed wiring is corrected, then all will be at the 1 watt level – the full R@R brightness.

Trade damage and Theft management

R@R allows immediate recognition if a Trade cuts the wiring. During the months between rough electrical and final trim, any wire that is cut – will clearly show in that the room has no light.

Ready @ Rough 'Wall' device

The ATX LED Wall device provides always on light at the same level in the entire project – this light level is 1/6 of normal levels, and equates to hanging lamp cords. The suggestion is that one temporary cord to the central power panel provides light to the entire project.

Wiring Validation

Ready @ Rough allows all the wiring in a house to be validated and activated prior to wallboard. This is a major time saver – and clearly shows if the wallboard or other trades have damaged the wiring. Different aspects of the wiring will be Validated by R@R . Follow the arrows on the “Work” device to connect the wires from the wall switch (UP) thru each fixture until it returns to the wall switch via :”DOWN”. Use these photos for the colors recommended.

Next Gen: Introducing Light @ Rough

An advanced version 'Wall' device is part of the L@R family. Light@Rough provides full light between electrical rough and trim. The ATX LED Wall+ has a touch sensor and alert. The Touch sensor allows the light to be at high brightness for one hour, before reverting to a dim level. The high level allows precision work, and the dim level provides light to avoid worker injury on objects in an otherwise would be dark room. Touch the Wall device and light will be on for 1 hour. The dim level is also intended for when workers are installing sheetrock and would be working near the lights. The ATX LED Wall+ device also has an alarm that if a wire is cut, or a LED is removed, an alarm goes off, this will let the worker know that he cut a wire, and it will be annoying – in order to encourage no more cuts.

Close up of the Work light wiring

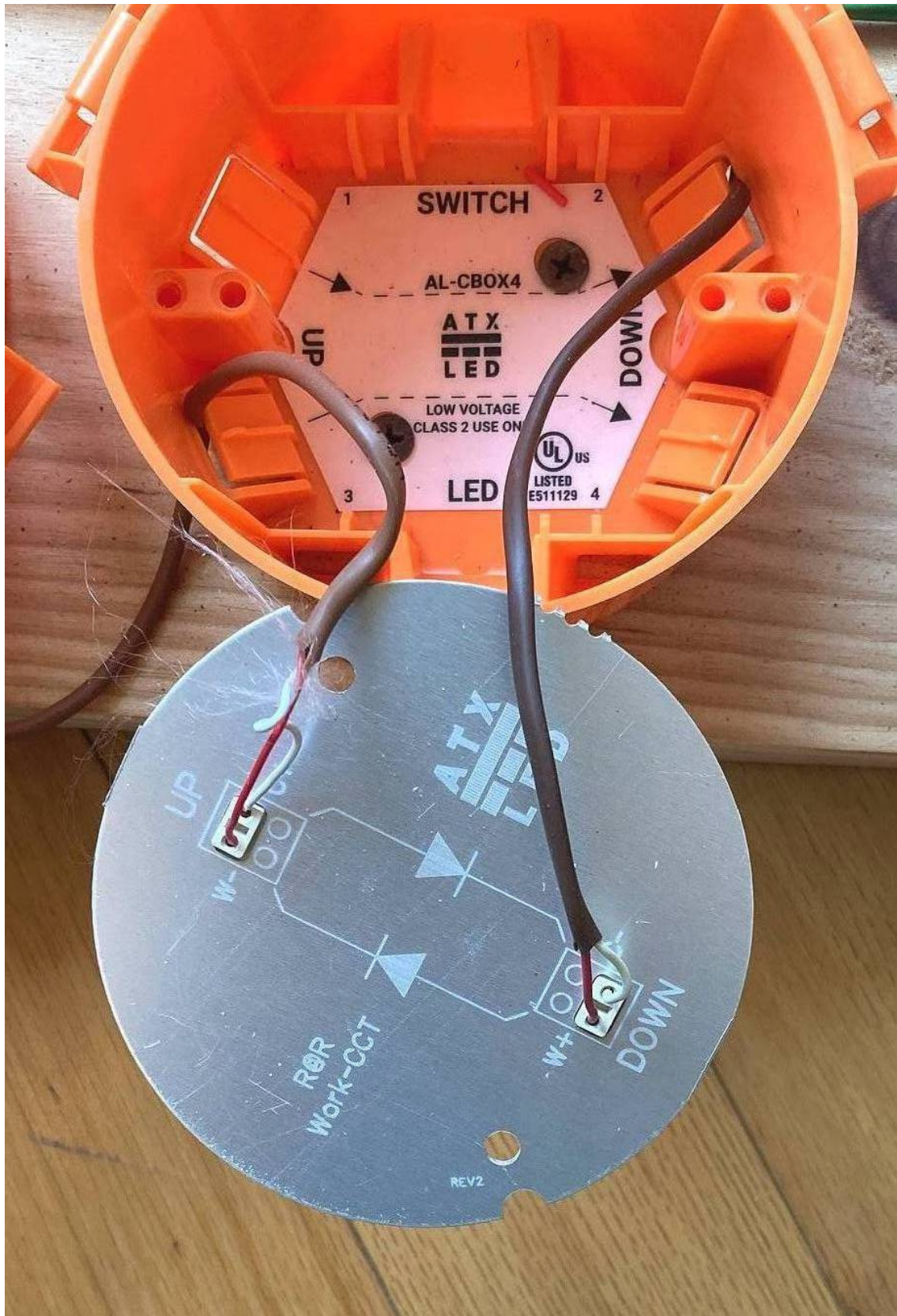

Close up of the 2-Gang Wall unit

Cool Cool Warm Warm
UP Down Down UP

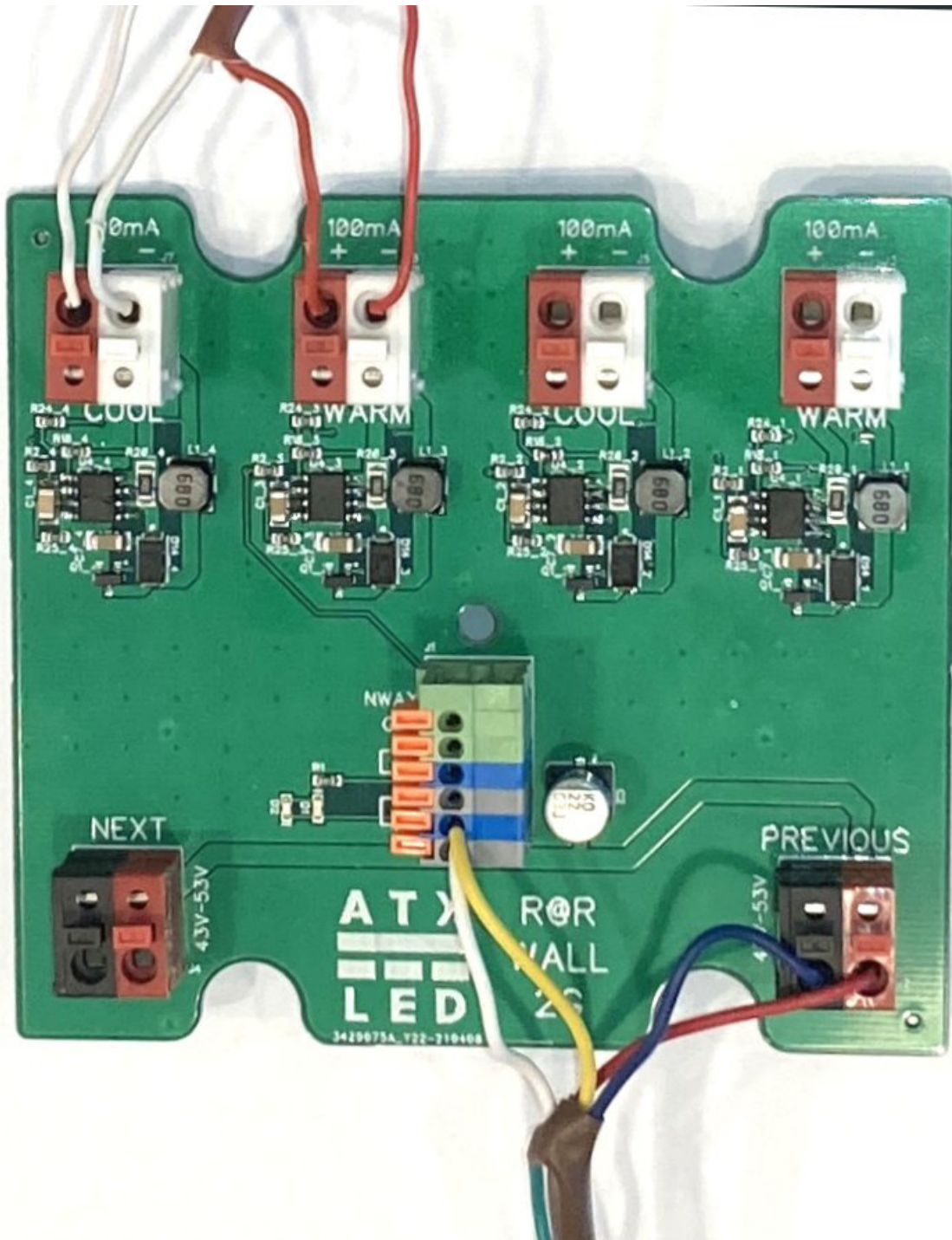



Installed



Lit



Reversed LED
is Red

Red LED showing
means the Up/Down
is reversed

fixed quickly before
sheetrock

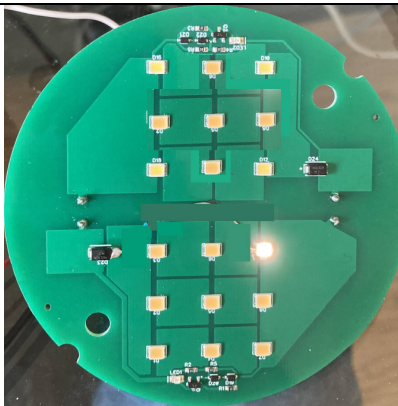

Too Many LEDs
in String

Just one LED showing
means too many in
a series string



2 gang open



2 gang ready



1 gang open



1 gang ready

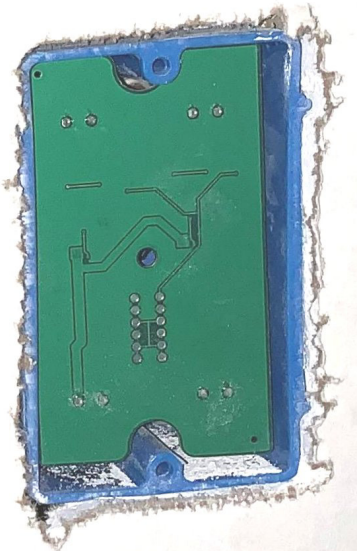

Sheetrock in place
no Rotozip damage

Primary light Wiring Validation – the R@R “Wall”

Starting with the room closest to the central power panel, wire the “Previous” as the feed into the switch, and the “Next” to the next multi gang box in line. Wire the DA lines for control from the Previous feeding thru to Next. Wire the Warm and Cool LED outputs as needed for the project. See our examples.

The presence of power, of control and confirmation of operating drivers allows the home run wiring to be validated.

The “Wall” device will show Blue for 48v power, one White LED for each LED output, Green or Amber for Control.

3-Way Wiring Validation

If your project uses simple 3-way switching, the remote wiring location can be easily verified by connecting the 3-way pair to the N-Way input on the “Wall” device. Then – shorting the remote end of the pair will turn the overhead lights off. Thus one person can check out all the wiring.

Door Jam Validation

Door Jam switching can be validated by connecting the alarm contact to the N-Way input and moving the magnet to simulate open/closed doors, the main overhead lights will turn on and off with the magnet.

Control Bus Validation

The DA connections are used to show that the Control bus has power. The Green or Amber lights will show if all is good.

[Specifications AL-R@R Work](#)

LED Power	Spring loaded connectors (2 pairs) for AWG 16-20 wire
Forward LED lighting	Up to 3.50 watts of LED lighting Limited to 200 mA
Reverse LED indicator	RED led in case of reversal limited to 5 mA
Size	Fits ABB and ATX ceiling boxes B620K
Dimming	Can dim to 1% using an ATX Driver
	Two models of R@R Work exist
2 versions	‘CCT’ 2 sets of LEDs for tunable white ‘48v’ for parallel wiring setups

[Specifications AL-R@R Wall](#)

Power source and Pass Thru	Spring loaded connectors (2 pairs) for AWG 16-20 wire
LED drivers	2, 4 or 6 LED drivers
DA Bus Test	Green or Amber LEDs 2 in and 3 out
N-Way test	2 pins
Power to LED	100 mA fixed (08 watt per LED)
FCC and interference	All outputs are RF filtered for minimal interference
Maximum output voltage	Input minus 4 volts
Optional Super Bright Timer	The L@R version has a touch switch this turns the current to 330 mA for 1 hour to allow bright light in the room